



skydeck  
— Usa —

skyjack pedestals **product information**



## intro to pedestals

Click here to view our pedestals introduction video.

## adjustable pedestals



**SD-XXS**  
3/8" - 5/8"



**SD-XS**  
5/8" - 1.25"



**SD-S**  
1.25" - 1.95"



**SD-M**  
1.75" - 2.95"



**SD-L**  
2.95" - 6"



**SD-XL**  
5.9" - 13.75"



**SD-XL + SD-XL-EXT**  
13.75" - 21.75"  
Add more for heights up to 38"



## fixed height pedestals

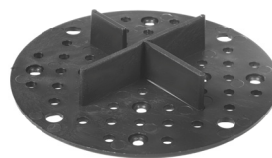

**SD-TS - 1/16" Gap Spacer**  
For use on roofs, concrete or on grade over a prepared level base.



**SD-00 - 1/4" Stackable**  
Stacks up to 1.25" tall, use shims for smaller height adjustments.

# skyjack pedestal accessories

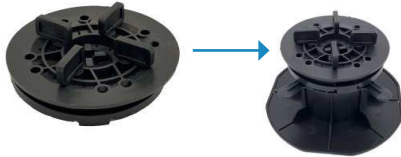
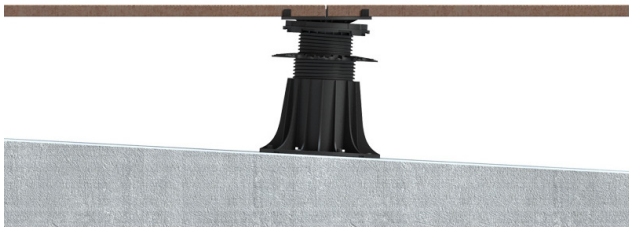

### Self-Leveling Heads

Self-leveling heads snap on top of any adjustable pedestal.

For accomodating slopes up to 6%.



### Base Slope Corrector

Base slope correctors snack onto the bottom of SD-M, SD-L and SD-XL pedestals.

For accomodating slopes up to 8%.

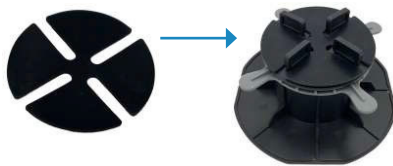

### Self-Leveling Heads

Self-leveling heads snap on top of any adjustable pedestal.

For accomodating slopes up to 6%.

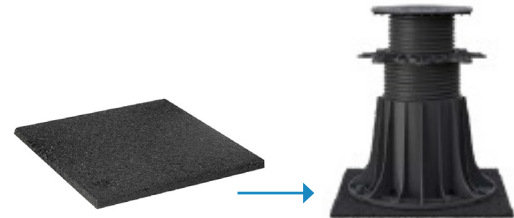

### Roof Protection Pads

Protection pads dampen sound and protect the waterproofing membrane.



### Joist Adapter Heads

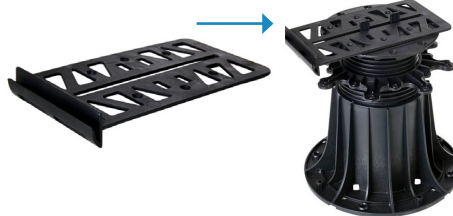

### Wall Clips for Perimeter Pedestals



### Height Extender Sleeve

8" Extender to add height to SD-XL pedestal. Stack up to 3 extenders for pedestal heights up to 38".



Intended Uses:

SKYJACK adjustable pedestals are used to support raised rooftop terraces to create level patios on top of roofs that slope up to 7% taking once wasted rooftop space and making it a showcase space for any building. SKYJACK adjustable pedestals can also help eliminate more expensive patio supports like steel or wood frames with a weight bearing capacity of up to 2,150 lbs. per pedestal.

Application:

SKYJACK pedestals are uniquely designed to achieve perfectly level patios with the easy twist of our screw ring. Set up your laser level, place pavers or decking on top of the pedestals and twist until level. Simple, easy and perfect results every time.

Calculating # of Pedestals([click here for an automatic product calculator](#))

1. Calculate the total # of pavers (ie - 46 pavers)
2. Calculate the total # of pavers needed around the perimeter and divide by the width of the paver (typically 2') (ie - 26 - 2'x2' pavers, so  $26/2 = 13$ )
3. Add the totals together ( $46 + 13 = 59$ )
4. Add 5% for waste ( $59 * .05 = 2.95$ )
5.  $59 + 3 = 62$  pedestals needed

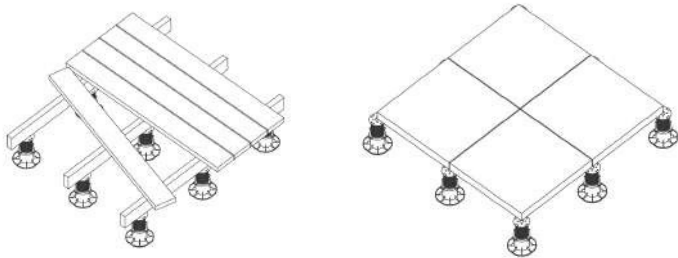

\*\*SKYJACK pedestals can be used with any size or shaped materials including decking and concrete pavers. Simply remove spacer tabs and re-position in the holes that provide appropriate spacing

SKYJACK adjustable pedestal system  
by skydeck usa

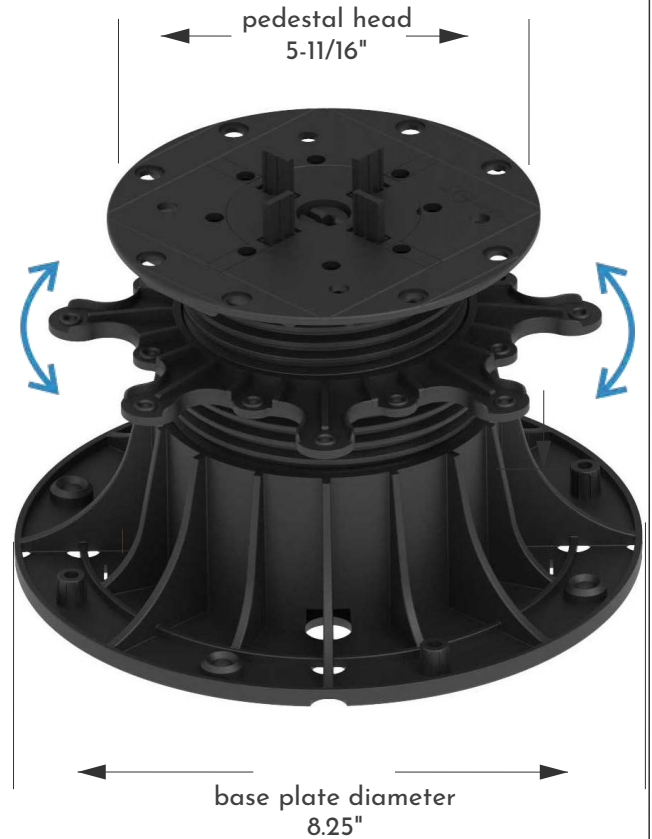

- 1 wide, stable base
- 2 screw ring for height adjustment
- 3 head with screw
- 4 removable spacer tabs

**Material:** Fully Recyclable High Density Copolymer Poly Propylene(HDCPP)



**Temp. Range:**  
-20 to 200 degrees fahrenheit

**Weight Capacity:**  
2,150 lbs per pedestal

**Atmospheric Conditions:**  
Resistant to UV Radiance, Aging and Decay



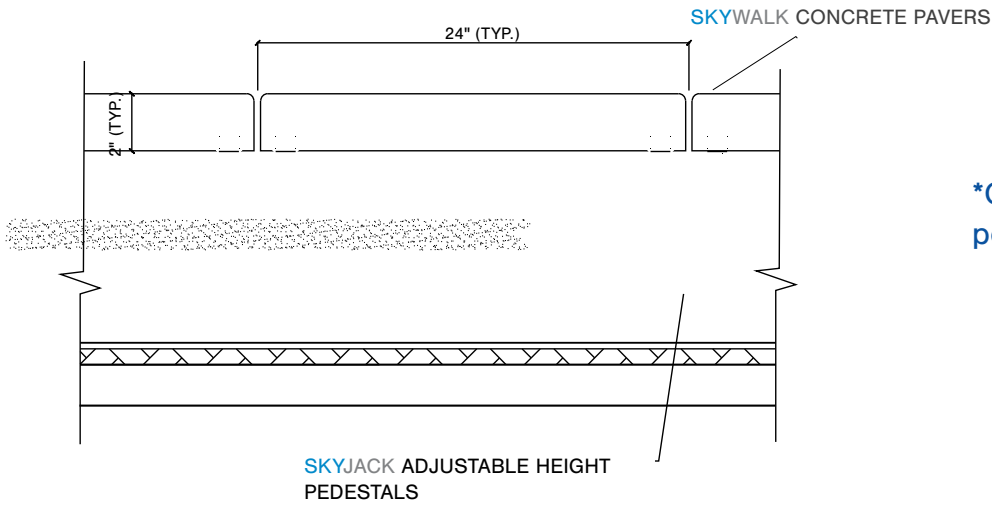
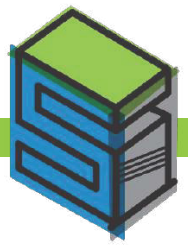

[\\*Click here to view our pedestal installation video](#)

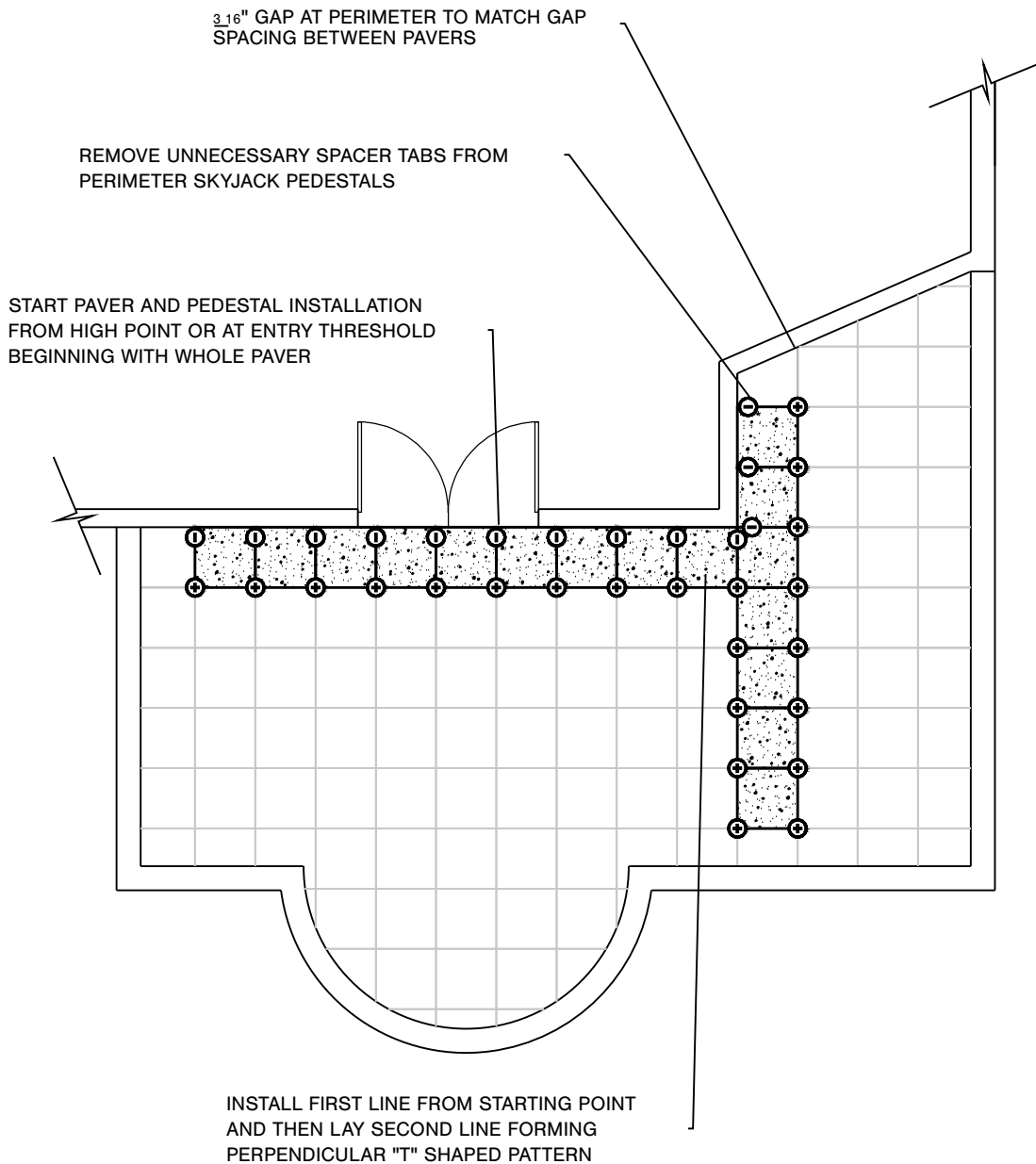



**skydeck**  
**usa**  
Rooftop Patios. Simply Done.

# SkyJack Spiral Series Adjustable Pedestals

For Low Height Adjustment from .375" up to 1.95"

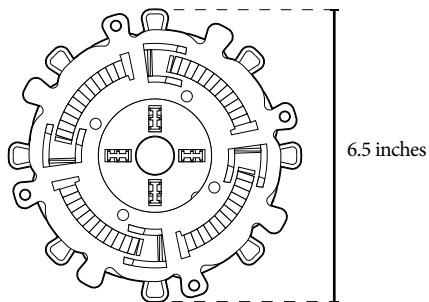

Introducing the new **SkyJack** low height spiral adjustable pedestal. This revolutionary product will save time and labor by allowing for low height adjustments unprecedented in the industry. Other low height products require stacking multiple shims on top of one another which is time consuming and very difficult to get perfectly level. This new **SkyJack** Adjustable Pedestal removes all the difficulty by allowing for height adjustments of just 1mm with the simple rotation of the pedestal head. The SD-0.5 low height adjustable pedestal has a removable, rotating gap spacer disc for use with pavers and tiles. Or, remove that spacer disc to use our standard 3/16" gap spacer tabs. SD-0.5 is also compatible with our deck joist adapter heads making it versatile with any flooring product you choose!

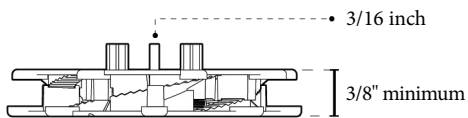

Product names:

**SkyJack SD-XXS - 3/8" - 5/8"**  
**SkyJack SD-XS - 5/8" - 1.25"**  
**SkyJack SD-S - 1.25" - 1.95"**

- Adjusts in 1 mm height increments
- Provides all benefits of adjustable pedestals





### Gap spacers

Compatible with standard  
3/16" gap spacers



### Rotating spacer disc

Removeable, rotating spacer disc  
makes creating perfect tile  
spacing a breeze



### Joist adapter

Compatible with  
our SD-AD deck  
joist adapter heads

ADJUSTS IN 1 MM HEIGHT INCREMENTS FOR MAXIMUM FLEXIBILITY

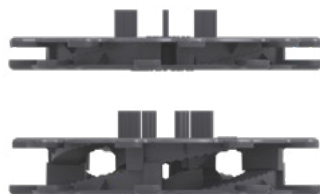

**skydeck**  
**USA**

Rooftop Patios. Simply Done.



## SkyHeights Pedestal System

For pedestals between  
21.75" and 45.75" tall

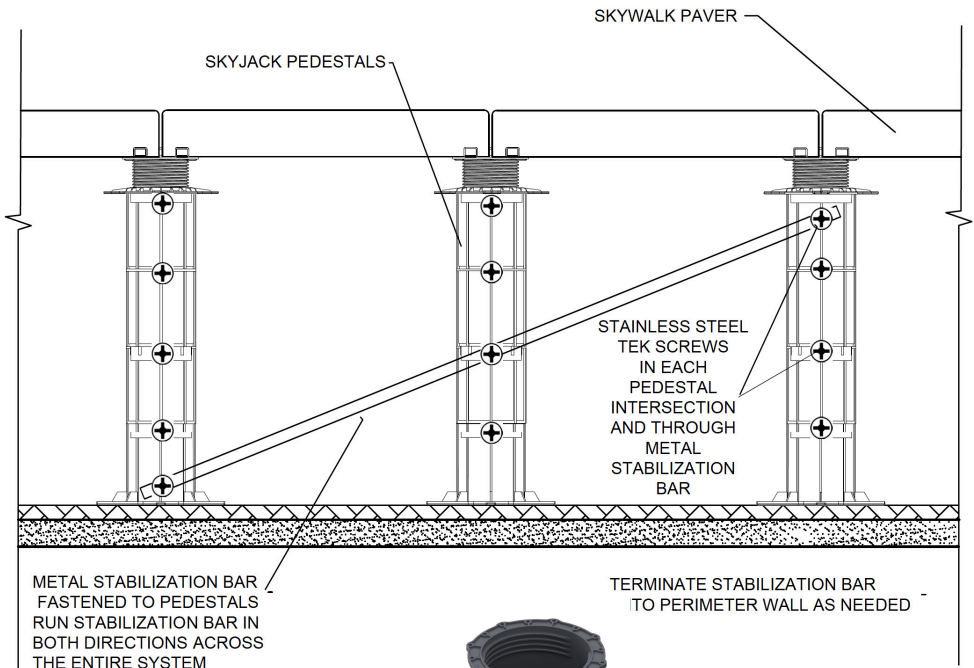

Extruded aluminum with mill finish  
0.050" Thick X 1" Wide X 10' Long



8" Extender  
Sleeves Screw  
Into Each Other



18-8 Stainless  
Steel Screws